



# NCT100/NCT200

## USER GUIDE



REF No.: DOC0052

ISSUE: 4.3

21 March 2017



## Contents

1	SCOPE .....	1-1
2	INTRODUCTION.....	2-1
2.1	Overview .....	2-1
2.2	Standalone Operation .....	2-1
2.3	Online Operation (NCT200 only) .....	2-2
2.4	Counting Requirements.....	2-3
3	INSTALLATION.....	3-1
3.1	Mounting the Unit.....	3-1
3.2	Power Supply and Cabling Requirements .....	3-2
3.2.1	Power Supply .....	3-2
3.3	Connecting the Count Inputs and Outputs.....	3-3
3.4	Connecting the VMS Control Bus .....	3-3
3.5	Connecting the Counter Reset input.....	3-5
3.6	Connection to a PC .....	3-5
4	PROGRAMMING THE NCT .....	4-1
4.1	Programming Overview .....	4-1
4.1.1	Passwords .....	4-2
4.1.2	Programming Menu.....	4-2
4.2	Initial Configuration .....	4-3
4.2.1	Configuration.....	4-3
4.2.2	Set Counts .....	4-5
4.2.3	VMS Settings .....	4-5
4.2.4	Date/Time .....	4-9
4.2.5	Clear Events .....	4-9
4.2.6	General Password.....	4-9
4.2.7	Set Debounce .....	4-10
4.2.8	Set Reset Time .....	4-10
5	TECHNICAL DETAILS .....	5-1
5.1	Specifications .....	5-1
	APPENDIX A – VMS-RGB Configuration .....	A-1



## **1 SCOPE**

This User Guide covers the installation and programming of NCT100 and NCT200 counting devices.



## 2 INTRODUCTION

### 2.1 Overview

The Nortech NCT100 is a four-channel counting module that can be used as a standalone unit providing up to 4 individual counters.

The NCT200 provides all of the functionality of the NCT100 but can also be included as part of a count management system by linking it to the server PC of the count management software (NorVenue or NorParc).

To avoid confusion, where operation is common between the NCT100 and the NCT200, we will refer to the device as 'NCT'. When the additional networking features are being discussed, we will explicitly refer to the 'NCT200'.

When in standalone mode, one or more Variable Message Signs can be associated with each of the counters to provide information of space availability to staff and visitors. Up to two alarm outputs can be associated with each counter to indicate that the count has reached a predetermined value. The outputs can be used to operate Open/Full signs, traffic lights or other external indicators as necessary.

When used with a count management system, the NCT200 can be networked to the server via either RS485 or TCP/IP. The outputs from the NCT200 can be controlled directly from the software to support centralised control of signs, alarms, door/barrier control arming, etc.

#### Features

- Provides up to 4 individual counters for recording the number vehicles or personnel entering or leaving a controlled area
- Each counter can count record values between  $-32500$  and  $+32500$
- Both increment and decrement inputs (up to 4 of each, depending upon configuration)
- Each counter can be individually configured to count up or down
- Alarm output when count reaches a preset threshold
- Pre-alarm output when count reaches a separate preset threshold
- Drives up to four individual Variable Message Sign count values
- Drives up to eight individual Variable Message Signs when linked to count management software (NCT200 only)
- Can be programmed directly using a full numeric keypad and 2-line x 16-character LCD
- Can be managed remotely via an RS485 network (NCT200 only)
- Each counter can be reset to a pre-determined value via a general reset input
- Password protected

### 2.2 Standalone Operation

Each counter can be configured to have either maximum or minimum thresholds and a starting value can be set. Typically, the starting value will be zero for counters that count up, or to the capacity of the facility for counters that count down. Each counter has at least one increment count input and one decrement count input. A pulse from a voltage free (normally open) contact connected between a ground pin and the input will cause the counter to count in the corresponding direction.

Up to 2 thresholds (alarm and pre-alarm) can be set for each counter where, when the count reaches the value of the threshold, an alarm output is activated. This output remains active while the value is at or beyond that threshold.

**Note:** The behaviour of the alarm depends on whether the counter is configured to count up or count down. Where the counter is configured to count up, the alarm is active while the value is equal to or more than the threshold; where the counter is configured to count down, the alarm is active while the value is equal to or less than the threshold.

The alarm output can be used to activate an alarm, to control a sign or traffic signal, or to disable an entrance or exit point. The pre-alarm threshold can be set to activate before the count value reaches the alarm threshold so that an early warning is given.

An example application for counting up is the recording of the number of visitors to a venue. The count is set to zero and the arrival of each visitor causes the value to increment so that the final value of the counter when the last visitor has arrived will be the attendance at the venue. An alarm can be given when the attendance is getting close to the capacity of the venue.

An example application for counting down is the management of a car park entrance, where entrance is denied to vehicles while the car park is full. The count value represents the number of free parking bays. Here, the count value is set to the total number of free spaces in the car park. As vehicles enter, the value decrements (meaning fewer available spaces). As vehicles exit, the value increments (meaning more available spaces). When the value reaches zero, the entrance barrier is disabled, thereby preventing vehicles entering the car park while there are no free spaces.

The current value of each of the counters is shown on the LCD screen.

All counters can be reset to their predetermined 'starting values' by the operation of an external button.

Where VMS's are attached to the NCT, they will be sent the current count values. Each VMS will display the count value that corresponds to its node number setting. If the data link is broken or if the NCT is in configuration mode, after approximately 45 seconds, each VMS will clear its display and show a series of bars to indicate a loss of communication. The correct displays will be restored as soon as the NCT returns to operating mode and/or the communication link is restored

### 2.3 Online Operation (NCT200 only)

When the NCT200 is online to a count management system, the following counter parameters are controlled directly from the software:

- Counting mode
- Count up or count down
- Alarm thresholds
- Reset values



Once the network has been configured, do not alter any of the configuration parameters in the NCT200 menu. All configuration updates must be carried out from the server software.

The increment and decrement functions operate in the same way as in standalone mode and the physical counters maintain up to 4 individual counts. The software polls the values of the counters in order to maintain a centralised database of physical counts. The data is used to calculate other



information such as group totals, total occupancy, etc. These values are stored as 'virtual counters'.

The physical counters in the NCT200 can be set, reset, incremented or decremented directly from the software.

Where VMS's are attached to the NCT200, they are not sent the current count values of the physical counters. Instead they are sent up to 8 virtual counter values configured in the software. Each VMS can be assigned a node number between 0 and 7 and will display a virtual count value that corresponds to its node number setting. The NCT200 buffers the virtual count values sent from the software and continues to send them to the VMS's locally.

If the data link is broken or if the NCT200 is in configuration mode, after approximately 45 seconds, each VMS will clear its display and show a series of bars to indicate a loss of communication. The correct displays will be restored as soon as the NCT200 returns to operating mode and/or the communication link is restored.

If communications with the PC is lost for more than 90 seconds, each VMS will clear its display and show a series of bars to indicate a loss of communication.

## 2.4 Counting Requirements

Before installing a standalone NCT, you need to determine how it will be configured. There are 3 counter modes available:

- 1-channel
- 2-channel
- 4-channel

The fewer the number of counters, the greater the number of increment and decrement inputs per counter (see table below):

Mode	Counters Available	Increment Inputs per Counter	Decrement Inputs per Counter
1-channel	1	4	4
2-channel	2	2	2
4-channel	4	1	1

Choose the appropriate mode before installing the NCT and terminating cables. Also determine how each counter will operate and which entrance/exit control devices will be used to increment and decrement the count value.

**Note:** if the NCT200 is to be connected to a count management system, the software will configure the operating mode. It is not necessary to set this up locally.



## 3 INSTALLATION

### 3.1 Mounting the Unit

The NCT can be wall-mounted when used indoors or fixed inside a weatherproof housing for outdoor use.

Identify a location convenient for cabling while ensuring that the LCD screen and keypad are easily accessible for programming the unit and carrying out diagnostics. Also ensure that the NCT is protected from excessive temperatures and moisture.

The mounting procedure is as follows:

1. Release the front cover from the main unit by pressing the securing buttons at the base of the unit while you lift off the cover from the bottom (hinging the cover at the top).
2. Carefully unplug the ribbon cable linking the cover to the main unit. Avoid pulling or bending the ribbon cable.
3. Completely remove the front cover.
4. Mount the unit on the mounting surface through the 2 keyhole slots and 2 mounting holes in the back plate. Use 4 appropriate screws or nuts/bolt (M4) according to the type of mounting surface.
5. After wiring the unit, replace the front cover by carefully inserting the end of the ribbon cable into the socket while supporting the cover with your other hand. Close the cover by engaging the buttons at the bottom of the unit and hinging the cover to lock the top. Apply a little pressure to the top of the cover until it clicks in place.

**Note:** If the unit is already mounted in a plastic enclosure with PSU, mount the enclosure as follows:

There are 3 mounting holes in the back panel of the enclosure with an optional fourth hole at the bottom of the back panel. Choose a location where there is sufficient space to run cables into one or more of the cable apertures (knockouts provided in top and bottom). Mount the unit on the planned mounting surface use 4 appropriate screws or nuts/bolt (M4) according to the type of mounting surface.

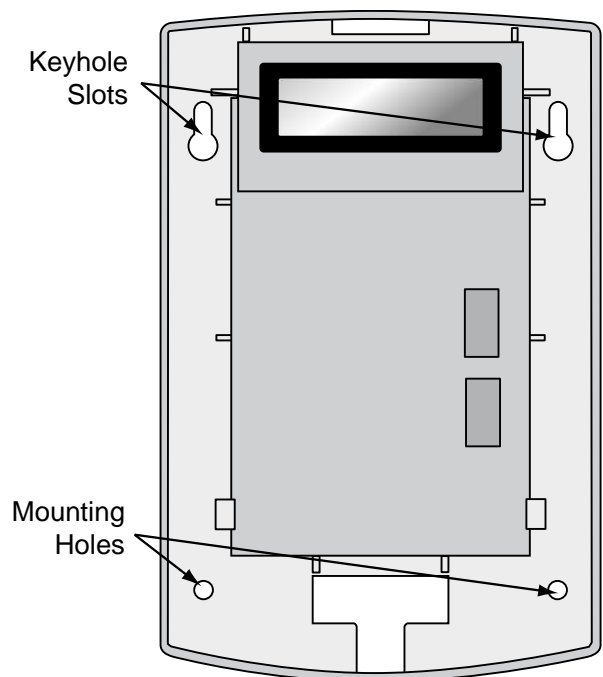
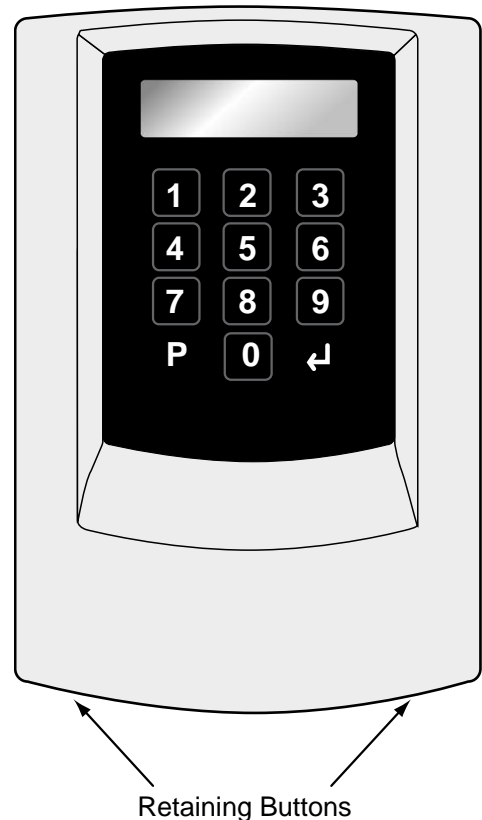

### 3.2 Power Supply and Cabling Requirements

The diagram below shows the NCT with the cover removed. All terminal blocks are shown.

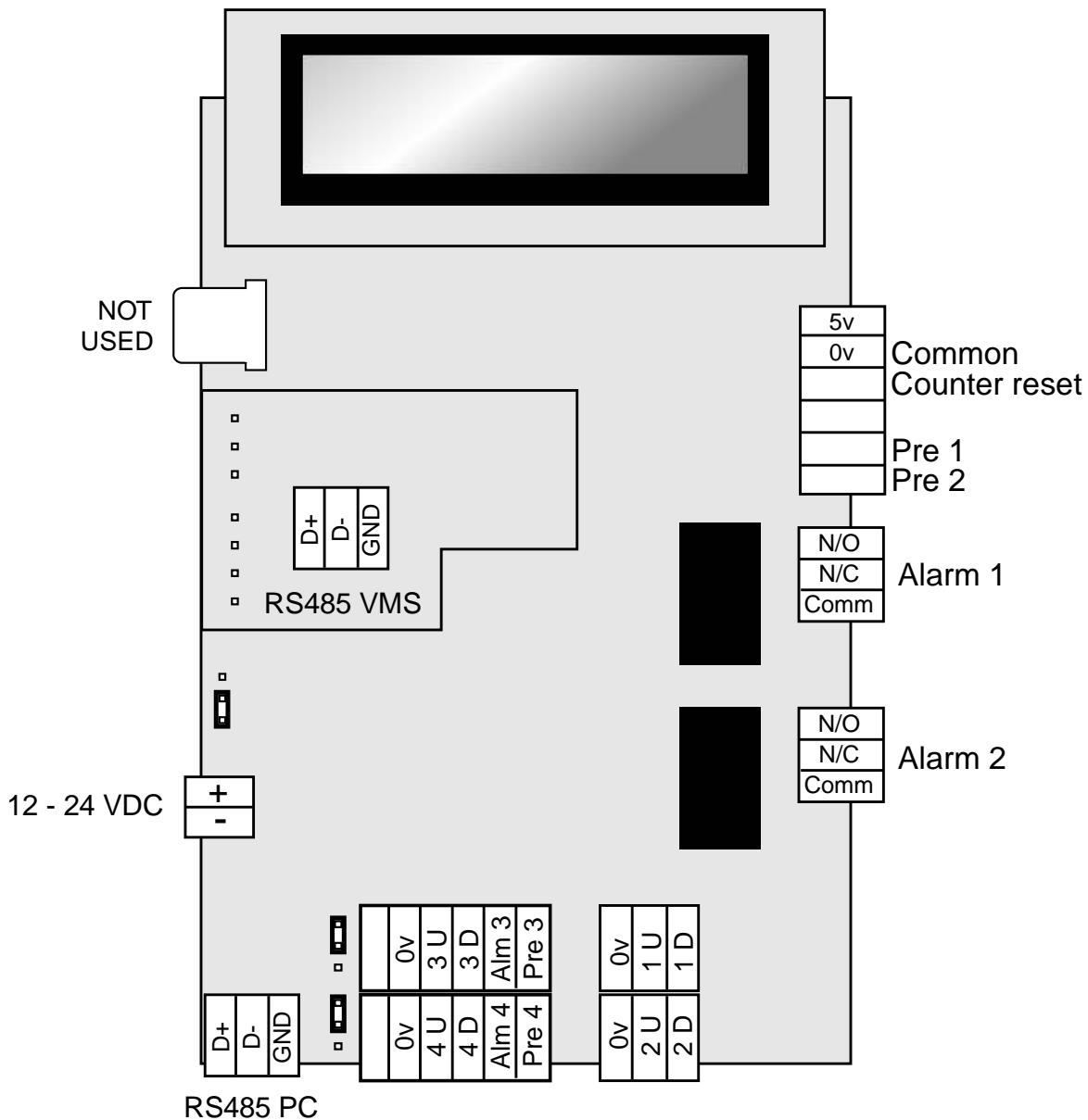

**Figure 3.1 – NCT Connection Diagram**

#### 3.2.1 Power Supply

The NCT must be fed from a suitable power supply that is capable of supplying a voltage between 12 and 24 volts DC. The supply quiescent current draw of the unit is less than 100 milliamps. This will increase to approximately 230 milliamps while all alarms are active.

Connect the power supply to the power input connector at the bottom left of the unit (see diagram above) Do not apply power at this stage.

### 3.3 Connecting the Count Inputs and Outputs

Each count input must be a voltage-free normally open contact and must be connected between 0v common and an appropriate count input terminal as shown in figure 3.1. Each input terminal is represented by a number and either 'U' for 'Up-count' (increment) or 'D' for 'Down-count' (decrement). The function of these terminals will depend on the operating mode (refer to table 3.1).

Alarm outputs 1 and 2 are implemented as voltage-free changeover contacts. All other alarm outputs and all pre-alarm are implemented as open collector outputs.

Where an open collector output is required to drive a large load such as an electric door strike or magnetic locking device, an intermediate relay circuit should be used.

A back EMF protection device must always be fitted where an inductive load, such as an electric door strike or magnetic locking device, is connected to the output relays. The protection device should be connected as close to the load as possible.

MODE	1	2		4			
	CHANNEL	CHANNEL		CHANNEL			
	Counter 1	Counter 1	Counter 2	Counter 1	Counter 2	Counter 3	Counter 4
Up-count I/P 1	1 U	1 U	2 U	1 U	2 U	3 U	4 U
Down-count I/P 1	1 D	1 D	2 D	1 D	2 D	3 D	4 D
Up-count I/P 2	2 U	3 U	4 U				
Down-count I/P 2	2 D	3 D	4 D				
Up-count I/P 3	3 U						
Down-count I/P 3	3 D						
Up-count I/P 4	4 U						
Down-count I/P 4	4 D						
Pre Alarm O/P	Pre 1	Pre 1	Pre 2	Pre 1	Pre 2	Pre 3	Pre 4
Alarm O/P	Alarm 1	Alarm 1	Alarm 2	Alarm 1	Alarm 2	Alm 3	Alm 4

**Table 3.1 – Terminal assignment according to operating mode**

Once all of the cables have been terminated, the cover can be replaced and the unit can be powered up.

### 3.4 Connecting the VMS Control Bus

The VMS control output is an RS485 control bus. All Virtual Message Signs must be connected in a 'Daisy Chain' and terminated on the RS485 VMS connector block. As with all RS485 networks, the cabling must conform to RS485 standards to ensure that the communication is reliable.

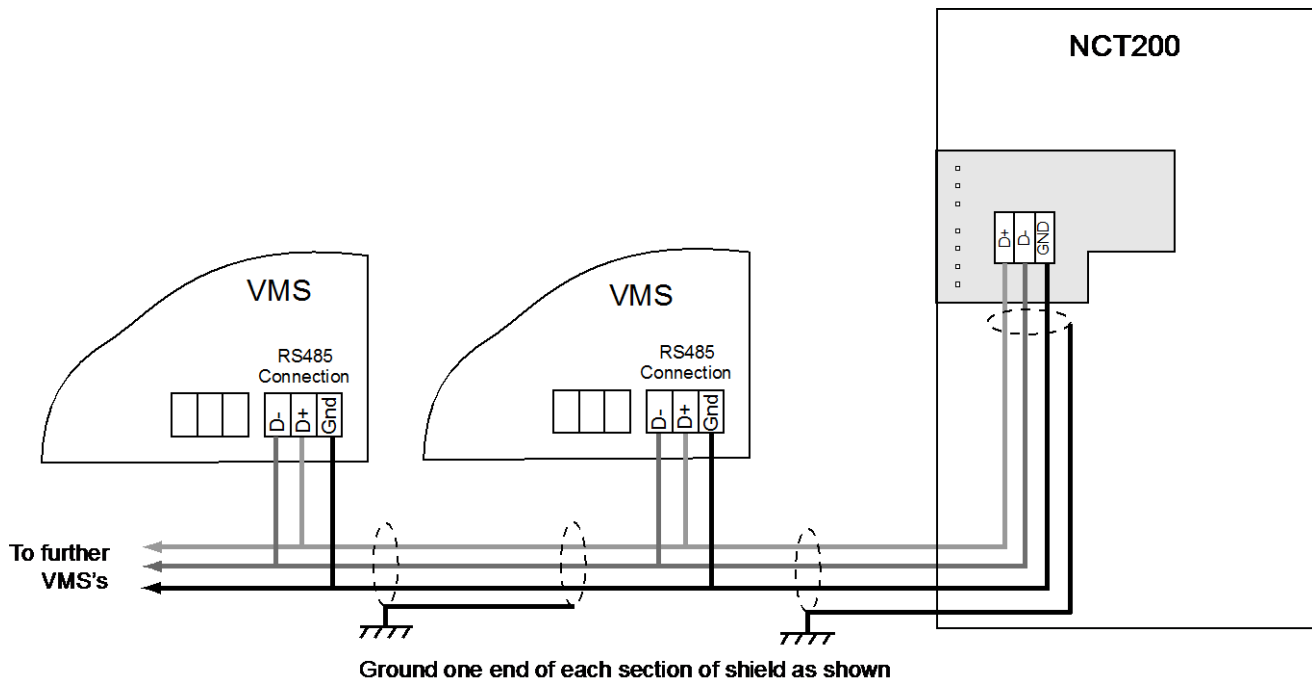

Use only screened twisted pair cable such as Belden 9729. The total length of the cabling must not exceed 1,200m. The screen of each length of cable must be connected to an earth point at one end only. Use one twisted pair for D+ and D- and the other twisted pair for ground (both conductors). It may be necessary to attach terminal resistors between D+ and D- at each end of the chain on longer cable runs.

Each VMS must be given a node number to identify which count value that it will display. For the NCT100 and where the NCT200 is in standalone mode, the VMS nodes are related to counters as follows:

VMS Node Number	Physical Counter
0	1
1	2
2	3
3	4

When the NCT200 forms part of a count management system, node numbers 0 to 7 are assigned to VMS's according to the application. The assignment of count values to nodes is controlled directly from the software (count values are from software 'virtual counters' not the physical counters within the NCT200).

**Note:** Any node number can be assigned to more than one VMS so that multiple signs can display the same count value.

### **3.5 Connecting the Counter Reset input**

When in standalone mode, the counters can be reset to their predetermined start values from an external device. Typically, this would be a normally open pushbutton. Connect the device between the common 0V terminal and the 'Counter Reset' terminal. Application of 0V to the 'Counter Reset' input causes all counters to reset to the value that was set as the reset value during the configuration (see 4.2.1).

### **3.6 Connection to a PC**

When the NCT200 forms part of a count management system, it must be connected to the PC hosting the server software via either an RS485 network or a TCP/IP network. For either type of network, the RS485 PC connectors are used to connect the NCT200 to either the PC directly or to a local thin server. Please refer to the appropriate count management system user guide for guidance on configuring and cabling the network.





## 4 PROGRAMMING THE NCT

Once the NCT has been installed and powered up, the next stage is the programming of the operating parameters to match the requirements of the installation.

### 4.1 Programming Overview

The NCT is programmed using the 12-digit keypad and 2-line LCD screen. The system is arranged as a hierarchical menu structure that can be navigated using the **P**, **0** and **↵** (enter) keys. The top line of the screen displays the current menu item and the bottom line displays the parameters.

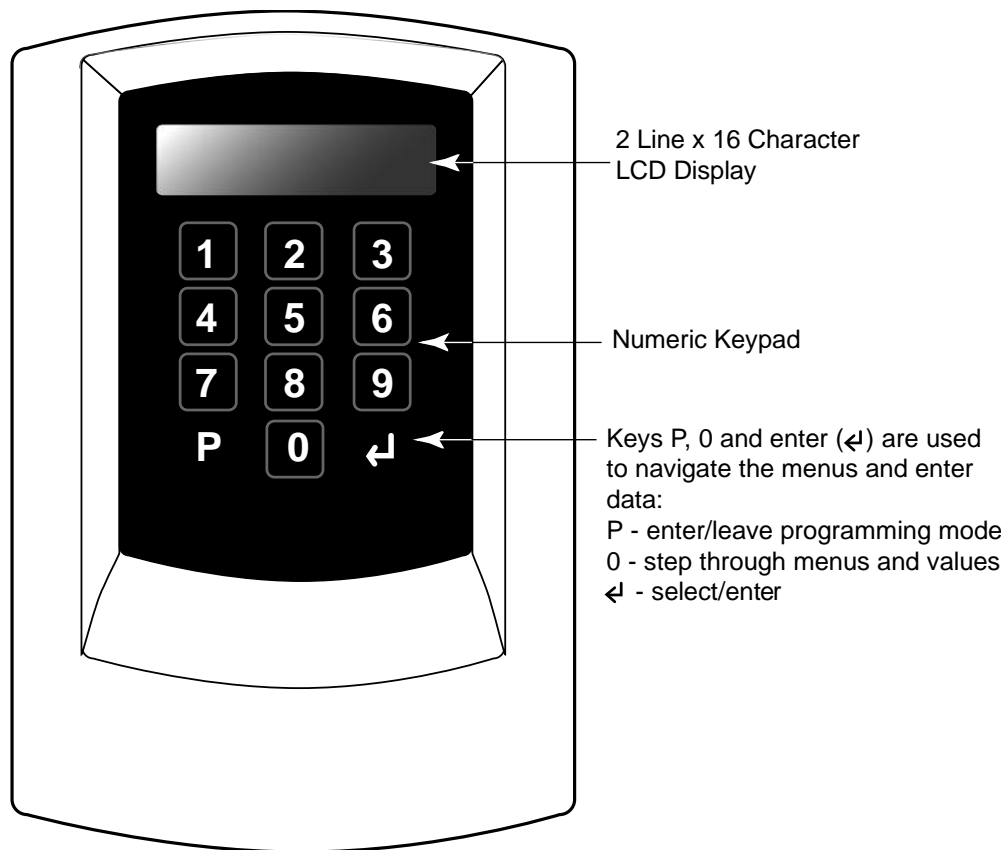

When you first switch the unit on it will briefly display the product code and the version number:

**NCTx00 Vx.xx**

It will then display the normal operation screen:

Counter 1	Counter 2								
↙	↘								
<table style="width: 100%; border: 1px solid black;"> <tr> <td style="width: 25%;">000001</td> <td style="width: 25%;">000001</td> <td style="width: 25%;"></td> <td style="width: 25%;"></td> </tr> <tr> <td>000001</td> <td>-00001</td> <td>00</td> <td></td> </tr> </table>		000001	000001			000001	-00001	00	
000001	000001								
000001	-00001	00							
↘	↙	Node							
Counter 3	Counter 4								

The screen layout will depend upon the operating mode set. The example above shows the NCT operating in 4-channel mode. There are 4 count values represented as 6 digit numbers with leading zeros. If the count value is negative the most significant digit is displayed as a minus sign (-) as in counter 4 in the example.

This operation screen is the starting point for each procedure described in this guide. The screen will revert back to the operation screen after 30 seconds of inactivity (30 seconds since last key was pressed).

Press **P** (program) to enter the programming mode. The display will show the first menu item. Press **0** to cycle through the menu items. To enter a particular menu item, simply press **↵** (enter) while the item is displayed on the screen. The first parameter of that item will then be displayed in the bottom row of the screen (unless you move to a sub menu).

To enter or change a parameter, type the new value and press **↵** (enter). The unit will then move to the next parameter.

To escape from a menu, press **P** once.

To go back to the operation screen, press **P** repeatedly.

#### 4.1.1 Passwords

There are two password protection options:

The general password check prevents unauthorised personnel from accessing any part of the programming system including count setting. This password can be enabled, changed and disabled from the main menu.

The configuration password check prevents unauthorised personnel from accessing the configuration menu. This password can be enabled, changed and disabled from within the configuration menu.

If a password is requested, you need to enter the appropriate 4-digit code and press **↵**.

#### 4.1.2 Programming Menu

The programming menu comprises the following items:

**Set Count:** this allows you to set the value of each of the counters

**Set Brightness:** this allows you to set the brightness of each of the connected VMS's

**Date/Time:** the real-time clock can be set here - not currently used in standalone mode

**Clear Events:** this allows you to clear events from the event log – not currently used

**Configure:** the mode and operating parameters are configured here

**Password:** the general password is set here

**Set Debounce:** this allows you to change the debounce setting for count inputs

**Set Reset Time:** this allows you to set a time when the counts are automatically set to their 'reset values'

## 4.2 Initial Configuration

### 4.2.1 Configuration

The first step is to set the operating mode and configure all of the operating parameters.

To reach the configuration menu from the operation screen, press **P** once and then press **0** repeatedly until the 'Configure' screen is displayed, and press **↵** once again. The following screen will be displayed:

```
Configure
Mode n CHANNEL
```

Where 'n' can be 1, 2 or 4.

This is the operating mode where you can choose between 1, 2 or 4 counters. Use the **0** key to step through the modes and press **↵** when the required mode is displayed.

The following screen will be displayed:

```
Configure
Node: n >
```

Where 'n' is the communications node.

This is only used when the NCT200 is online to a count management system. All controllers must have a unique node number. If necessary, enter a node number between 0 and 31 and press **↵**.

The following screen will be displayed:

```
Configure
Rst1: nnnn
```

Where 'nnnn' is the 'Reset' value of counter 1. This value would typically be set to the capacity of a car park or venue so that it can be reset to the correct value when empty. The counter is reset to this value when a ground is applied to the 'Counter reset' input.

Enter a count value between 0 and 32700 and press **↵**.

```
Configure
Ct1: Count Up
```

This is used to set the direction of count for counter 1 (see section 2.2). Use the **0** key to toggle between 'Count Up' and 'Count Down' and press **↵** when the required value is displayed.

The following screen will be displayed:

```
Configure
Alarm1: No
```

This allows you to set an alarm threshold value. Use the **0** key to toggle between 'Yes' and 'No' and press **↵** when the required value is displayed. Choose 'Yes' if you wish to set an alarm threshold or 'No' if it is not required.

If you choose 'Yes', the following screen will be displayed:

```
Configure
ALM1: nnn
```

Where 'nnn' is a threshold count value for counter 1 at and beyond which an alarm output is active (see section 2.2). Enter a threshold value between 0 and 32700 and press **↵**.

The following screen will be displayed:

```
Configure
Pre Alm1: No
```

This allows you to set a pre-alarm threshold value. Use the **0** key to toggle between 'Yes' and 'No' and press **↵** when the required value is displayed. Choose 'Yes' if you wish to set a pre-alarm threshold or 'No' if it is not required.

If you choose 'Yes', the following screen will be displayed:

```
Configure
PRE1: nnn
```

Where 'nnn' is a threshold count value between 0 and 32700 at and beyond which a pre-alarm output is active (see section 2.2). Enter a threshold value between 0 and 32700 and press **↵**.

The counter setting steps are repeated for all counters (regardless of the operating mode).

When the last counter parameter is complete, the following screen will be displayed:

```
Configure
Events? No
```

This gives you the option to record events. This is for future applications. Press **↵**.

The following screen will be displayed:

```
Configure
Password? No
```

This allows you to set a password for access to the Configuration menu. Use the **0** key to toggle between 'Yes' and 'No' and press **↵** when the required value is displayed.

If you choose 'Yes', the following screen will be displayed:

**C o n f i g u r e**  
**P a s s w o r d : >**

Enter a 4-digit number and press **↵**. This number will then have to be entered whenever the Configure menu is selected. Make sure that you keep the 4-digit password safe so that you don't need technical support to allow you into the configure menu.

On completion of the Configure Menu, the NCT resets and returns to the operating screen.

### 4.2.2 Set Counts

The 'Set Counts' menu item is the first item to be displayed when **P** is pressed from the operating screen. This is because this can be used during normal day-to-day operation to overcome incorrect counts caused by tailgating, maintenance work, etc.

The initial settings for the counters will depend upon their particular application (see section 2.2).

From the operation screen, press **P** once to show 'Set Counts' and press **↵**. The following screen is displayed:

**S e t   C o u n t s**  
**C t 1 :   n n n n n n**

Where 'nnnnnn' is the current count value for Counter 1. Enter a count value between 0 and 32700 and press **↵**. If the NCT is set to 1-Channel mode, the initial 'Set Counts' menu is shown.

Otherwise, the above process must be repeated for all configured counters. Press **P** to return to operating mode.

### 4.2.3 VMS Settings

Use this sub-menu to select and configure the signs that the controller will be driving. Two options are supported:

VMS-001 (RS485) - Standard, single-colour Nortech VMS, controlled via RS485.

VMS-RGB (RS485) - Nortech full colour VMS sign with several display options, controlled via RS485.

To reach the 'VMS Settings' menu from the operation screen, press **P** once and then press **0** repeatedly until 'VMS Settings' is displayed, and press **↵**. The following screen is displayed:

**V M S   S e t t i n g s**

Press **↵** and carry out the following procedure:

The currently selected VMS option is displayed. Use **0** to cycle through the options:

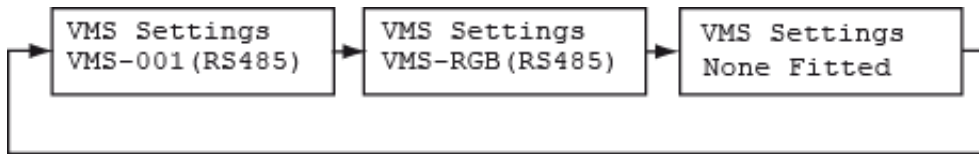

Once the required option is displayed, press **↵** once to save the selection.

If you selected 'None Fitted' go straight to Section 4.2.4. or press **P** to return to operating mode.

The procedures for configuring the VMS settings for each type of VMS are described below:

#### 4.2.3.1 VMS-001

If you selected VMS-001 (RS485), the following screen is displayed:

```
Set Brightness  
Node (0-3):
```

**Note:** For the NCT200, the node range available is between 0 and 7.

Enter the node value of the VMS you wish to adjust and press **↵**. The following screen is displayed:

```
Set Brightness  
Level (1-4):
```

Enter a brightness level between one and four and press **↵**. You will be returned to the top of the 'VMS Settings' sub-menu.

To escape from the 'VMS Settings' sub-menu, Press **P** to return to Operating Mode or press **0** to move onto the next menu item.

### 4.2.3.2 VMS-RGB

If you selected VMS-RGB (RS485), carry out the following step:

#### Display

#### Action

VMS Settings  
Set Node

To be able to communicate with the VMSs, each VMS must be assigned a node address between 0 and 3. Press **↵** if you wish to assign node addresses to the signs or press **P** to skip this item.

**Note:** For the NCT200, the node range available is between 0 and 7.

Fit 1 VMS only!  
Node (0-3):

To be able to assign a node to a VMS, connect only that VMS to the controller, enter the required node number and press **↵**. Repeat this procedure for each sign. Once all signs have been assigned addresses, they can be connected to the controller in a daisy chain as explained in Appendix A.

VMS Settings  
Config Node

The VMS-RGB can be configured for several types of operation, several LED colours and several brightness modes. Press **↵** to carry out the configuration of a node or press **P** to skip this item.

Config Node  
Node (0-3):

Choose which node you wish to configure. Enter the node number followed by **↵**.

**Note:** For the NCT200, the node range available is between 0 and 7.

The following configuration options are now available. Use **0** to cycle through the options:

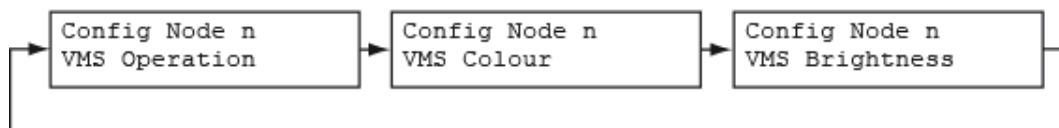

Press **↵** to select the displayed option.

#### VMS Operation

Use this to set which information will be displayed for positive and negative count values. When VMS Operation is selected, the following options are available. Use **0** to cycle through the options:

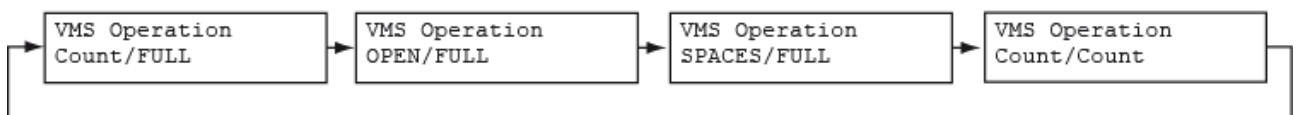

Where the two values shown represent the display for 'count value = 1 or more' / 'count value = less than 1'. 'Count' is the actual count value.

Press **↵** to select the displayed option. You can now use **0** to cycle through the VMS Config Node options if you wish to change another setting on that node, or press **P** to return to the top of the 'VMS Settings' sub-menu.

To escape from the 'VMS Settings' sub-menu, Press **P** to return to Operating Mode or press **0** to move onto the next menu item.

### VMS Colour

Use this to set the display colour for positive (1 or more) and negative (less than 1) values.

When VMS Colour is selected, the following positive value options are available. Use **0** to cycle through the options:

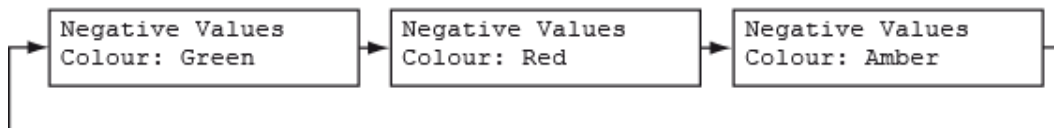

Press **↵** to select the displayed option. You can now use **0** to cycle through the VMS Config Node options if you wish to change another setting on that node, or press **P** to return to the top of the 'VMS Settings' sub-menu.

To escape from the 'VMS Settings' sub-menu, Press **P** to return to Operating Mode or press **0** to move onto the next menu item.

### VMS Brightness

This option allows you set the correct display brightness for your application. If set to 'Auto', the display brightness will be automatically adjusted to suit the ambient light level measured at the built-in light sensor. If you choose a fixed brightness level, the sign will continue to display at that brightness regardless of the level of ambient light.

When VMS Brightness is selected, the following options are available. Use **0** to cycle through the options:

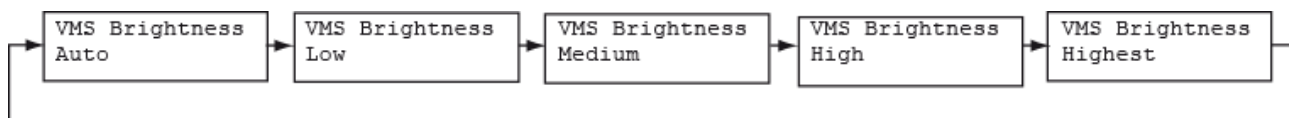

Press **↵** to select the displayed option. You can now use **0** to cycle through the VMS Config Node options if you wish to change another setting on that node, or press **P** to return to the top of the 'VMS Settings' sub-menu.

To escape from the 'VMS Settings' sub-menu, Press **P** to return to Operating Mode or press **0** to move onto the next menu item.



#### 4.2.4 Date/Time

This sub-menu item allows you to adjust the time and date in the unit's real time clock.

To reach this sub-menu item from the initial display, press **(P)** once and then press **(0)** repeatedly until the following screen is displayed:

**Date / t i m e**

Press **(←)** and carry out the following procedure:

Display	Action
<b>Date / t i m e</b> <b>Year : x x</b>	Enter the year as two digits and press <b>(←)</b> .
<b>Date / t i m e</b> <b>Month : x x</b>	Enter the month in two-digit format and press <b>(←)</b> .
<b>Date / t i m e</b> <b>Date : x x</b>	Enter the day of the month as two digits and press <b>(←)</b> .
<b>Date / t i m e</b> <b>Day : x</b>	Enter a number corresponding to the day of the week, with 1 = Monday, 2 = Tuesday, etc.
<b>Date / t i m e</b> <b>Hour : x x</b>	Enter the current hour as two digits and press <b>(←)</b> .
<b>Date / t i m e</b> <b>Min : x x</b>	Enter the current minute as two digits and press <b>(←)</b> .
<b>Date / t i m e</b> <b>Sec : x x</b>	Enter the current second as two digits and press <b>(←)</b> .

On completion, press **(P)** to return to operating mode.

#### 4.2.5 Clear Events

The 'Clear Event' menu item is for support staff only and should be ignored by normal users.

#### 4.2.6 General Password

To reach the password menu from the operation screen, press **(P)** once and then press **(0)** repeatedly until the 'Password' screen is displayed, and press **(←)** once again. The following screen will be displayed:

```
Pa s s w o r d
Pa s s w o r d :  N o
```

This allows you to set a password for access to the all settings including 'Set Counts'. Use the **0** key to toggle between 'Yes' and 'No' and press **↵** when the required value is displayed.

If you choose 'Yes', the following screen will be displayed:

```
Pa s s w o r d
Pa s s w o r d : >
```

Enter a 4-digit number and press **↵**. This number will then have to be entered whenever the Configure menu is selected. Make sure that you keep the 4-digit password safe to ensure that you can have access to the menu items in the future.

On completion, the NCT resets and returns to the operating screen.

#### 4.2.7 Set Debounce

This menu item allows you to set contact debounce time for the increment and decrement inputs so that, when relay contacts or switches operate, they don't register multiple inputs as they settle, thereby causing erroneous count values. This parameter should be left at its default value unless a contact problem has been identified.

To reach the 'Set Debounce' menu item from the operation screen, press **P** once and then press **0** repeatedly until the 'Set Debounce' screen is displayed, and press **↵**. The following screen is displayed:

```
S e t   D e b o u n c e
D b :  D e f = 2 0  >
```

Enter a value between 1 and 100 in milliseconds and press **↵**. The initial 'Set Debounce' menu item is shown. Press **P** to return to operating mode.

#### 4.2.8 Set Reset Time

All counters can be automatically reset (set to their reset values) once a day at a predetermined time. This menu item is used to set the reset time.

To reach the 'Set Reset Time' menu item from the operation screen, press **P** once and then press **0** repeatedly until the 'Set Reset Time' screen is displayed, and press **↵**. The following screen is displayed:

<b>S e t R e s e t T i m e</b> <b>H o u r : 2 3</b>
--

Enter a value between 0 and 23 for the required hour (0 = midnight) and then press **↵**. The following screen is displayed:

<b>S e t R e s e t T i m e</b> <b>M i n : 0 0</b>
--

Enter a value between 0 and 59 for the required minutes and then press **↵**.

Press **P** to return to operating mode.

**Note:** If you don't wish a daily reset to occur, ensure that you set the Reset Hour to a value above 23.



## **5 TECHNICAL DETAILS**

### **5.1 Specifications**

Description:	4-channel counting system
Counting capacity:	Up to 32700
Dimensions:	160mm x 120mm x 30mm.
Weight:	300 grams.
Supply voltage:	12 to 24 volts DC
Termination:	Pluggable screw terminal strip.
Display:	LCD, 2 lines x 16 characters.
Controls:	12 button membrane keypad, 0 - 9, Program, Enter.
Inputs:	4 counter increment inputs 4 counter decrement inputs 1 counter reset input
Alarm outputs:	2 independent voltage free changeover relays (2A, 30V DC) plus 2 open collector outputs
Variable Message Sign output:	RS485 communications port supporting 8 node addresses (8 individual count values)
Pre-alarm outputs:	4 open collector outputs.
Current requirement:	100 mA quiescent, up to 230mA while all alarms are active
PC Communications:	RS485 communications port for connection to count management server (NCT200).



